

EEN, EEV, EEJ

23
22
21
20
19
18
17
16
15
14
13
12

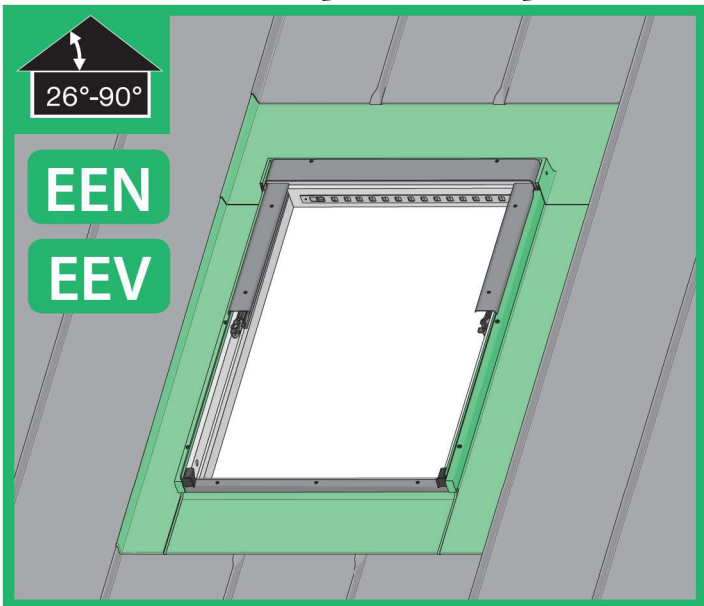

11
10
9
8
7
6
5
4
3

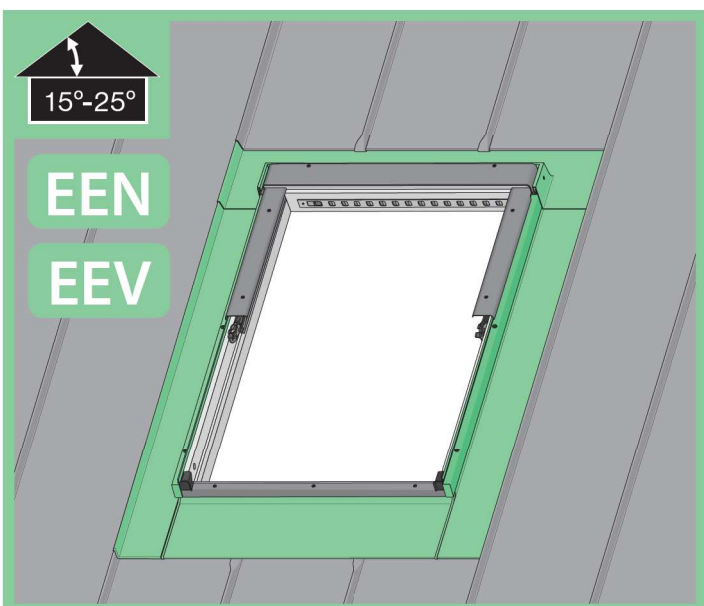

0 [cm] 1 2

NC 236 IM/EEN, EEV, EEJ/14.06.2016/F

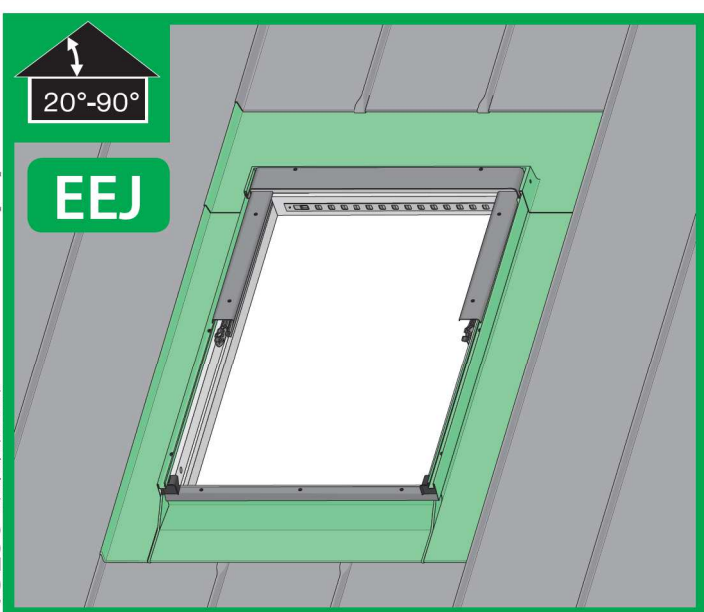

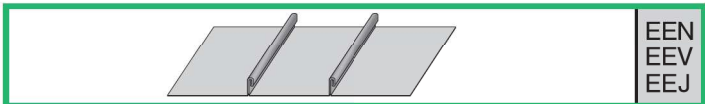
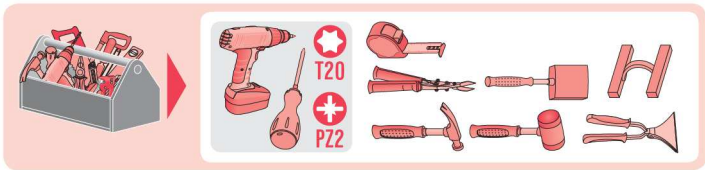

EEN
EEV
EEJ

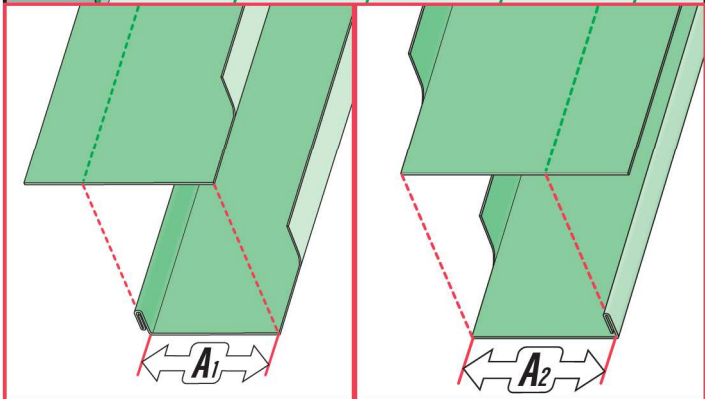
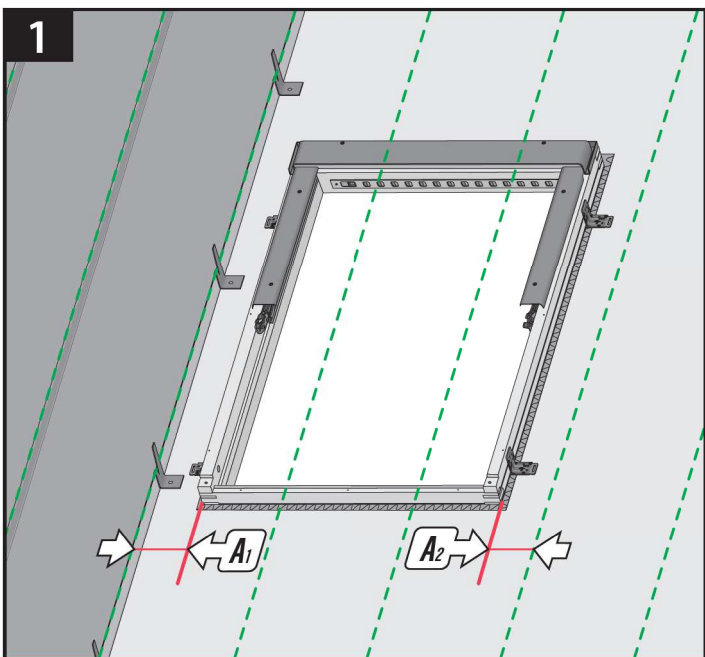
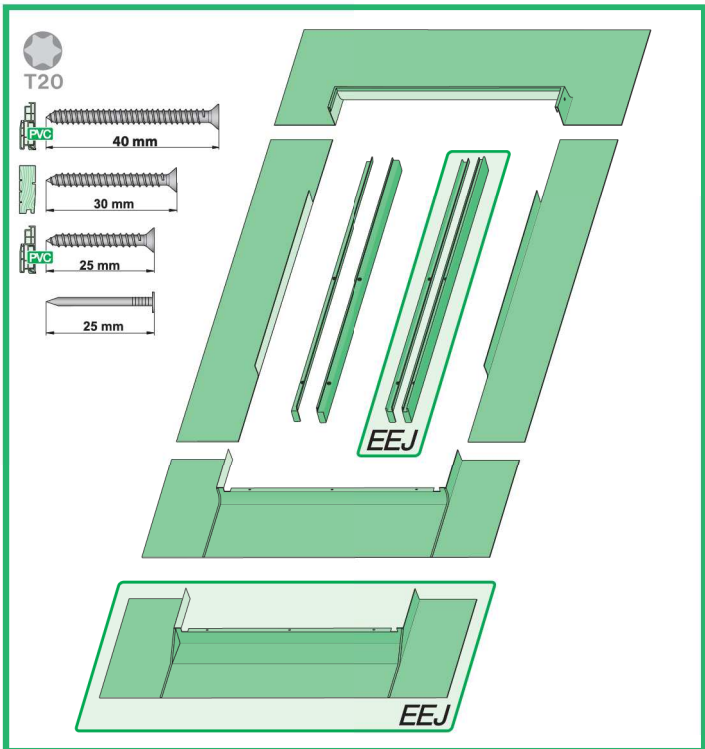

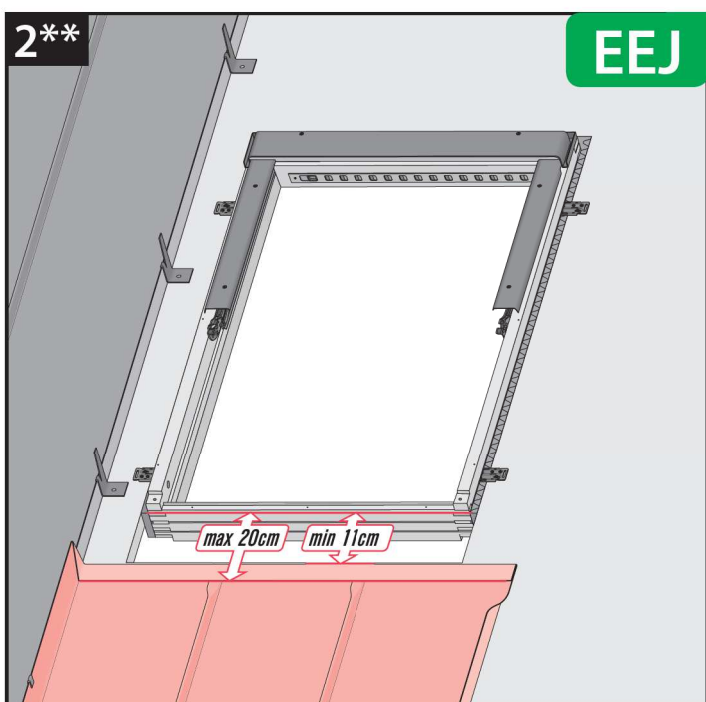
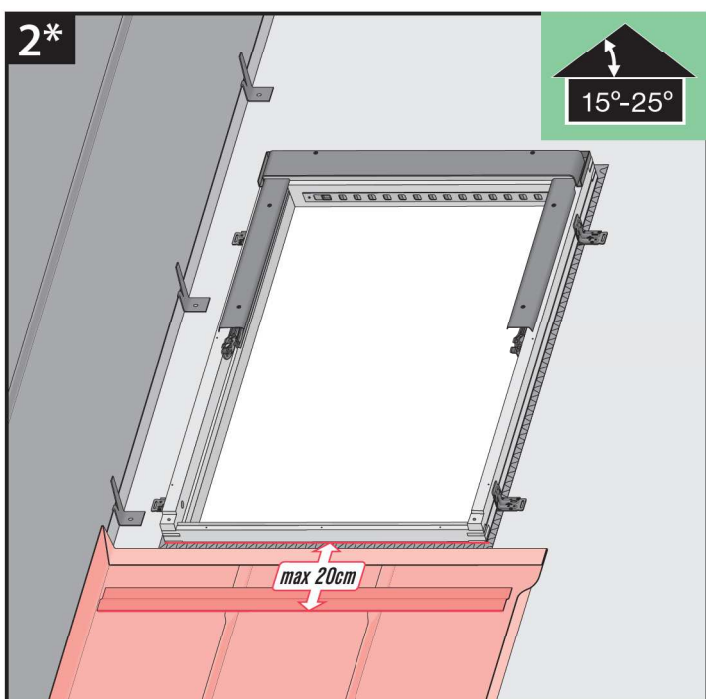
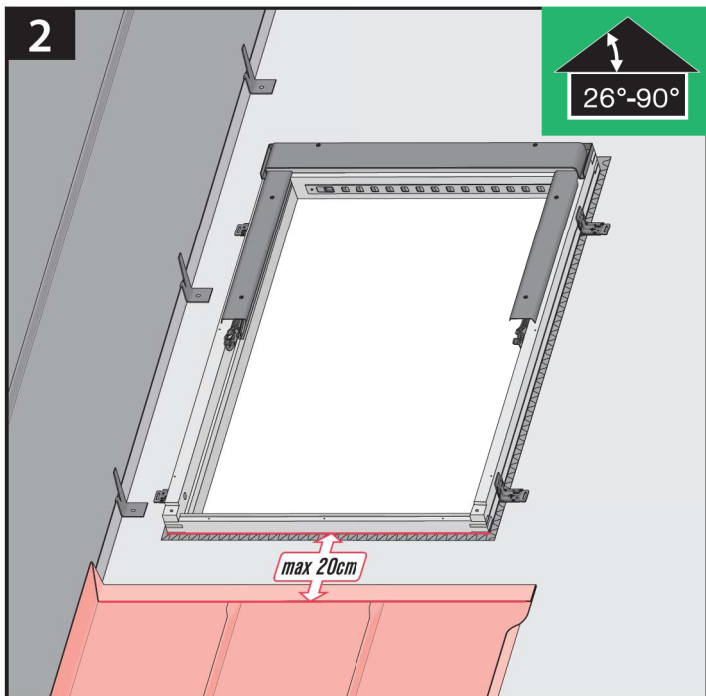

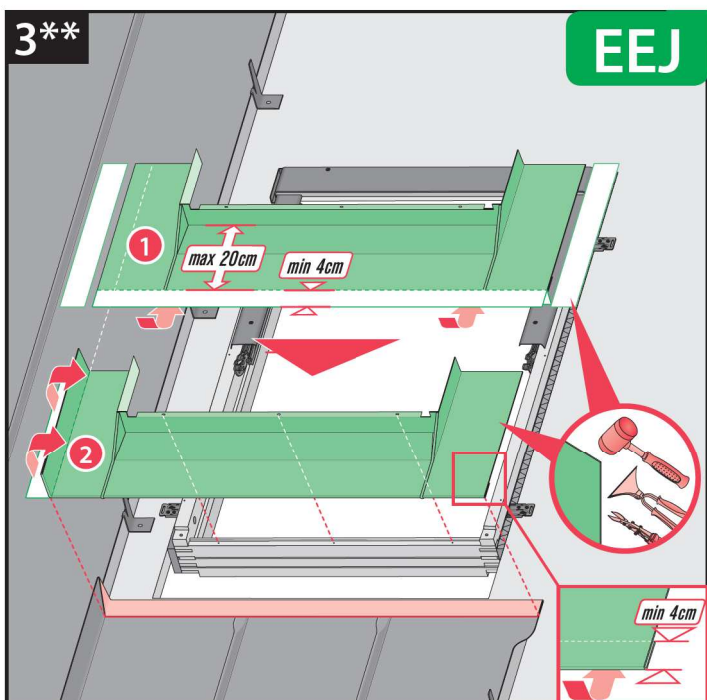
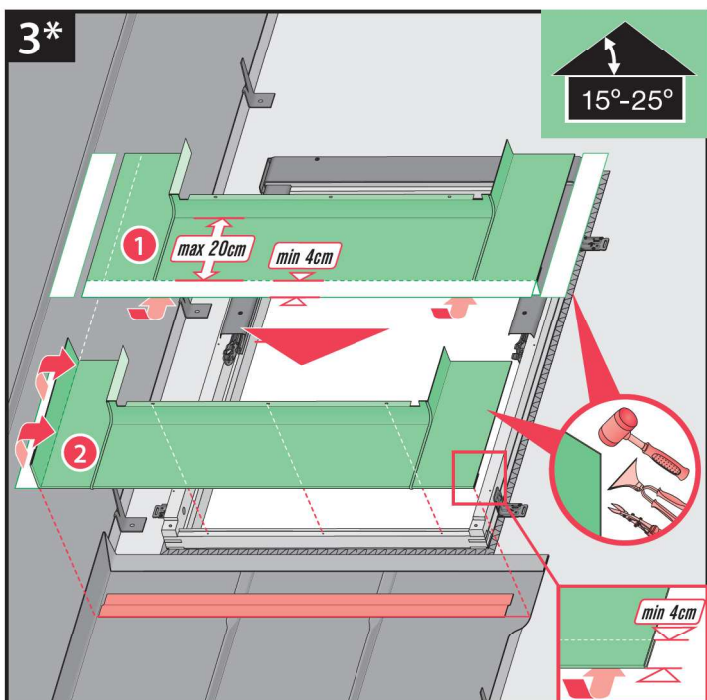
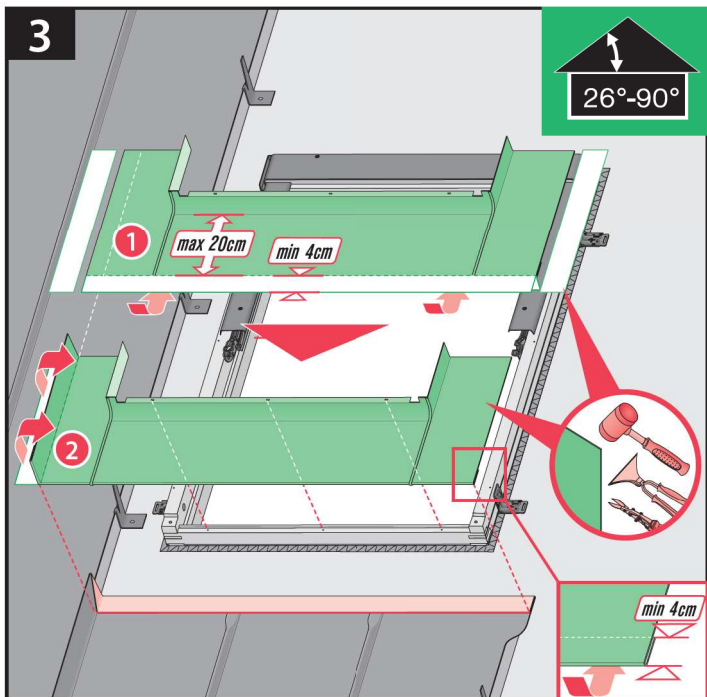

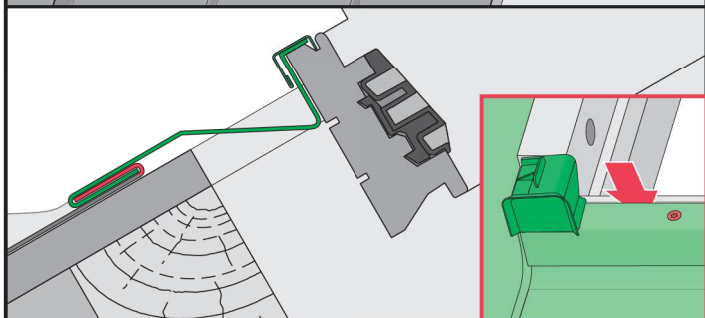
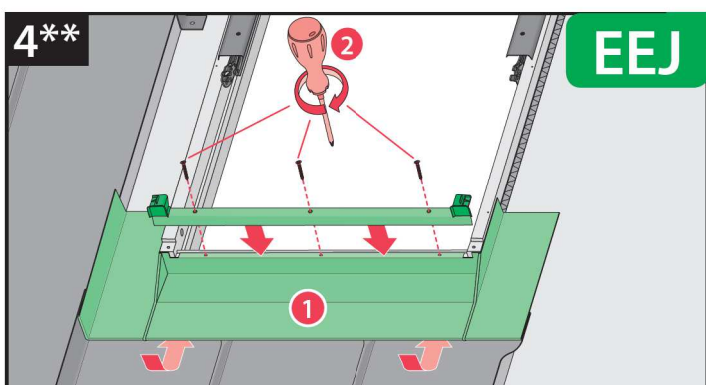
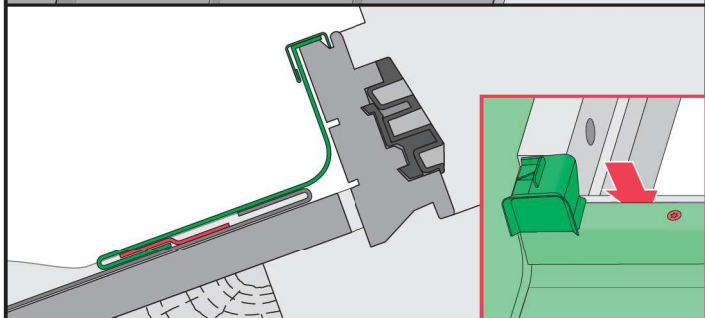
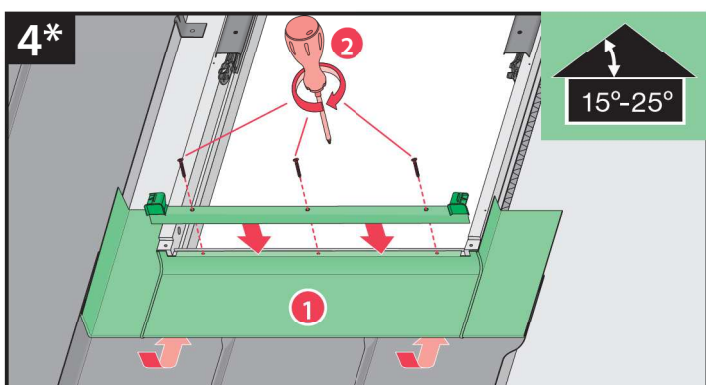
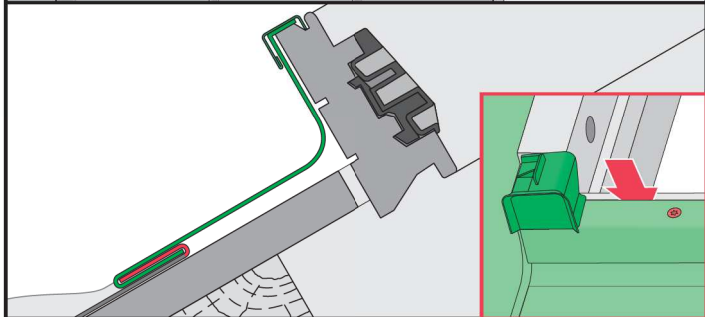
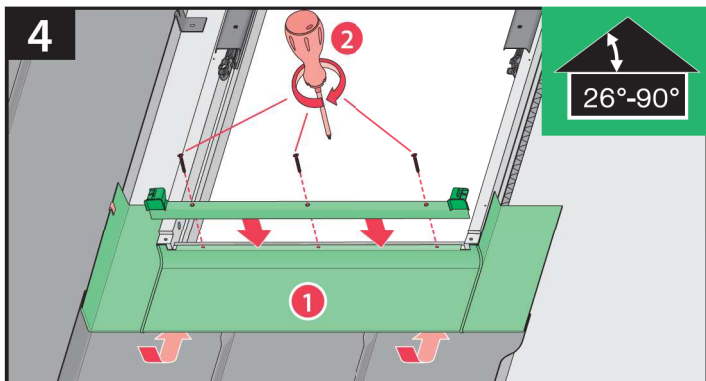

5a

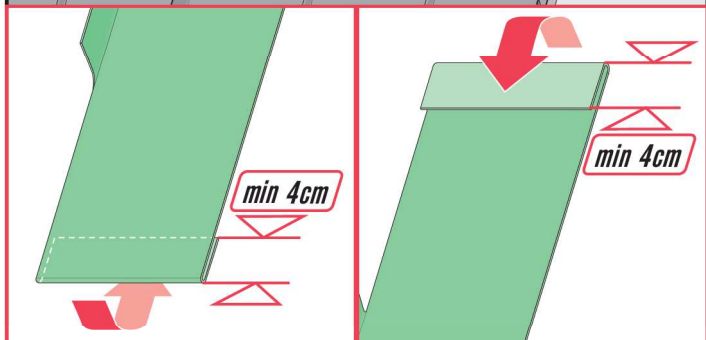
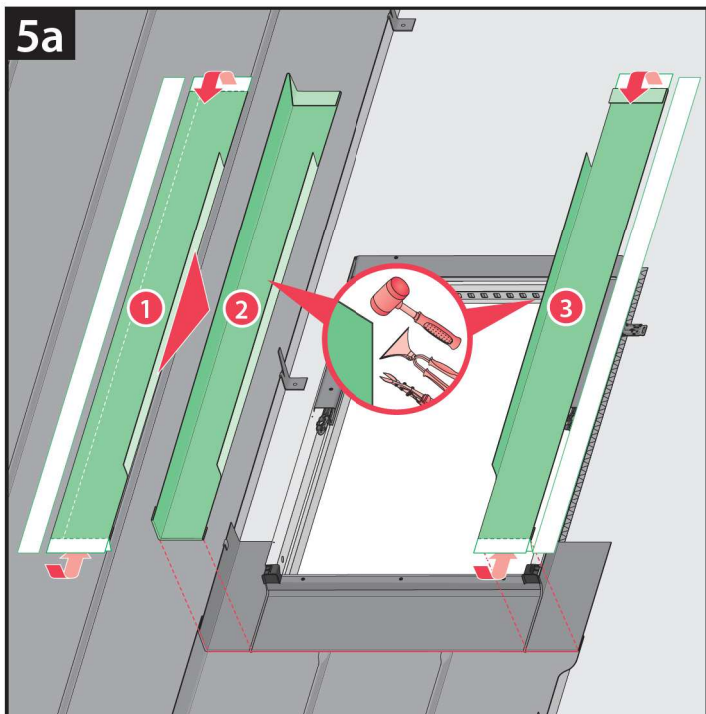

5b

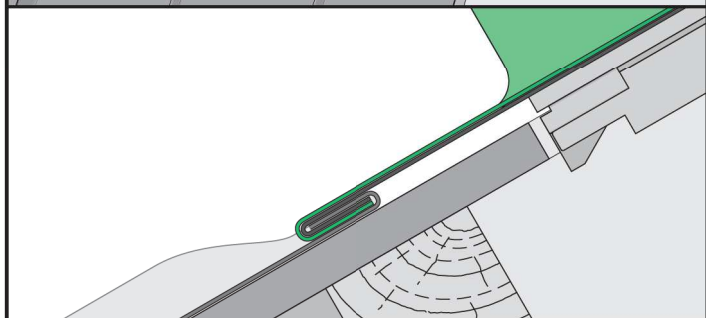
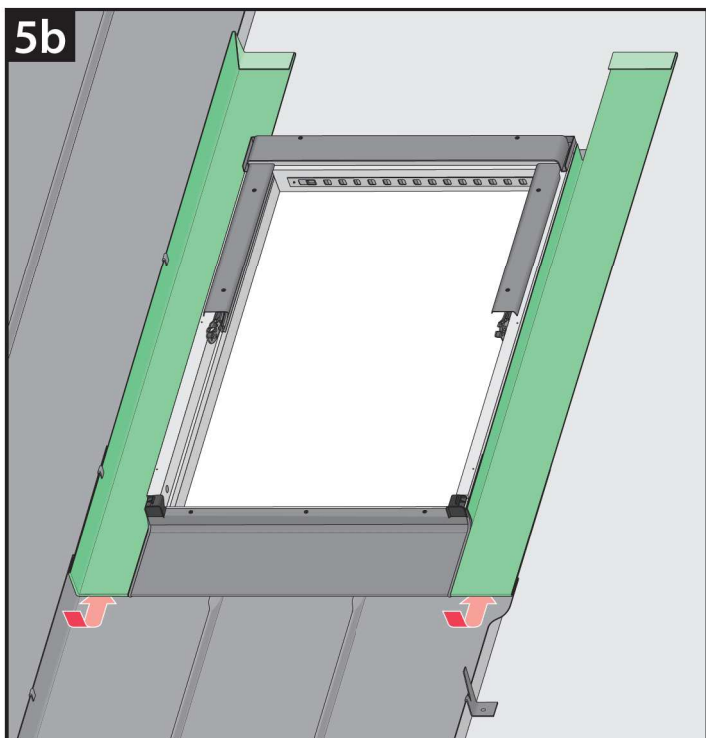

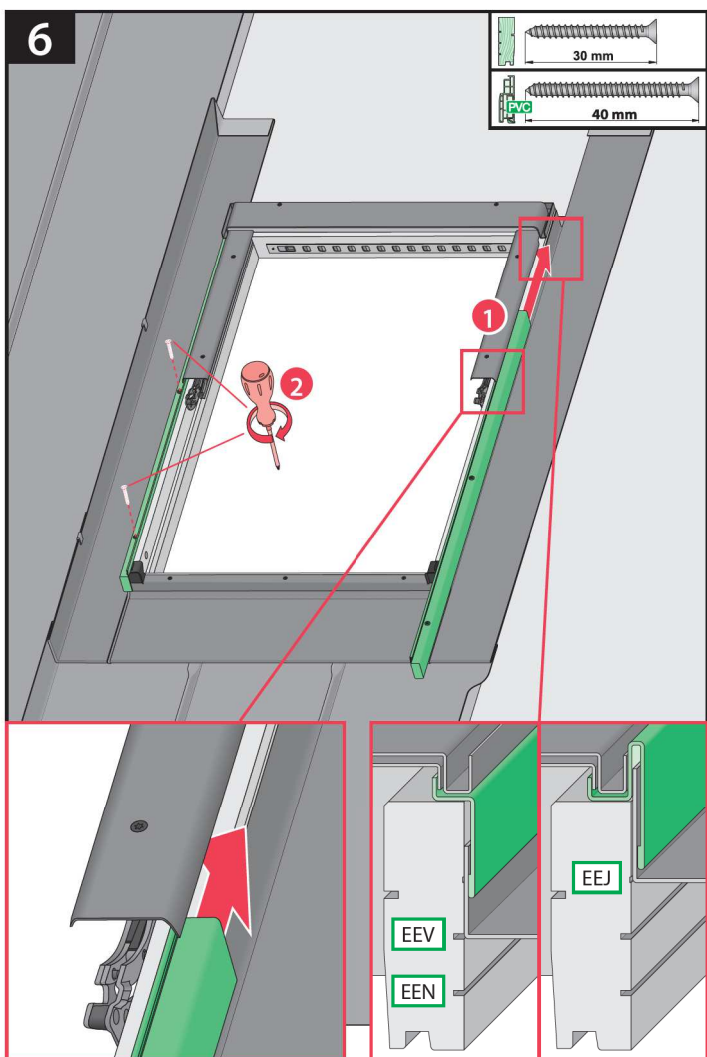
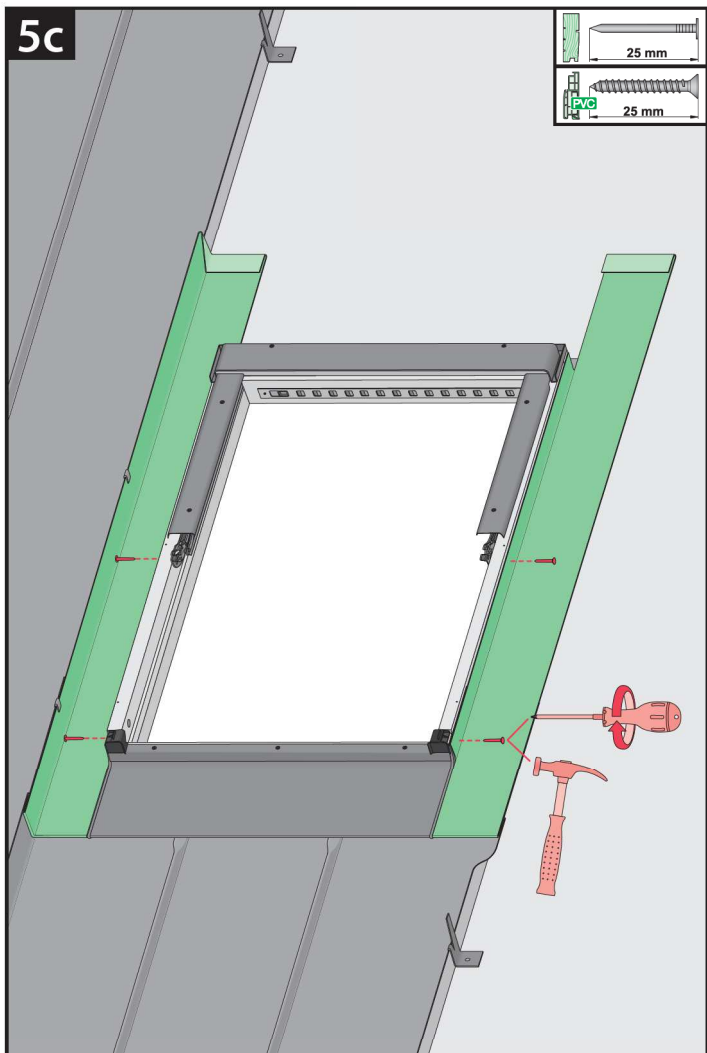

7

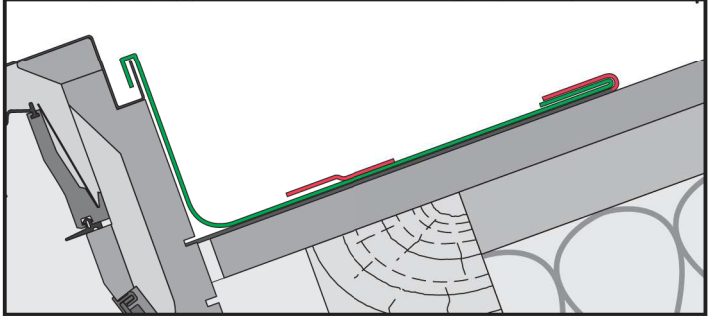
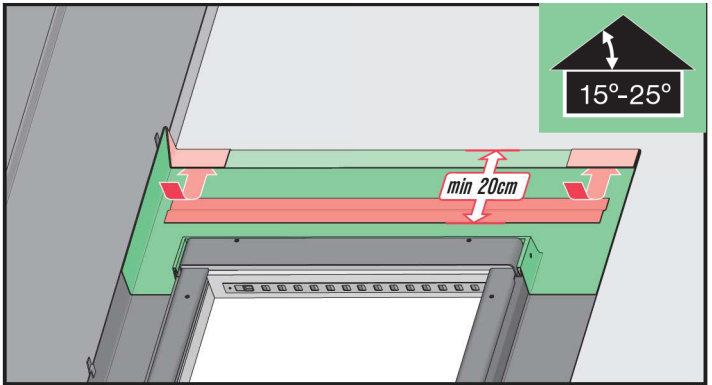
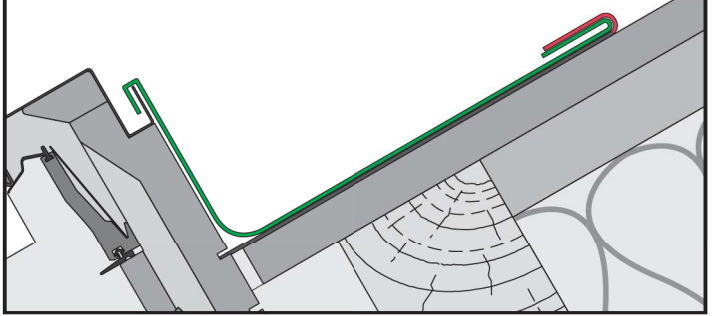
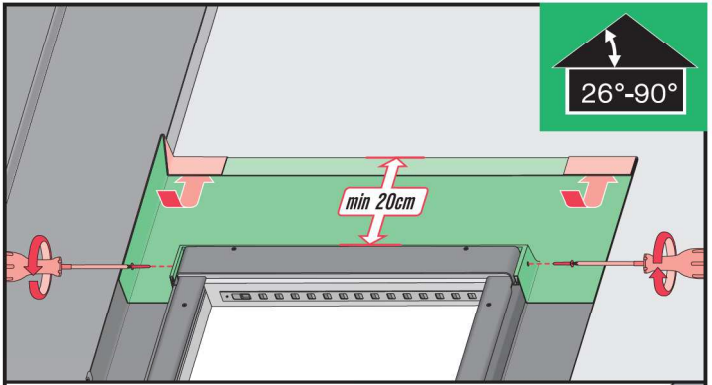
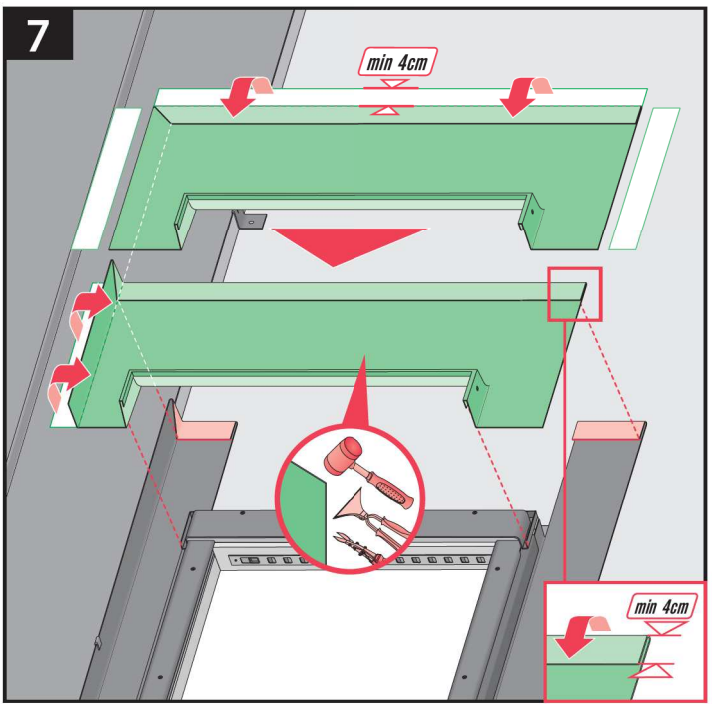

8

26°-90°

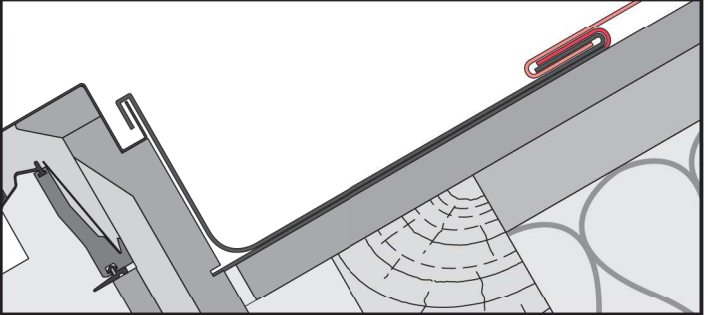
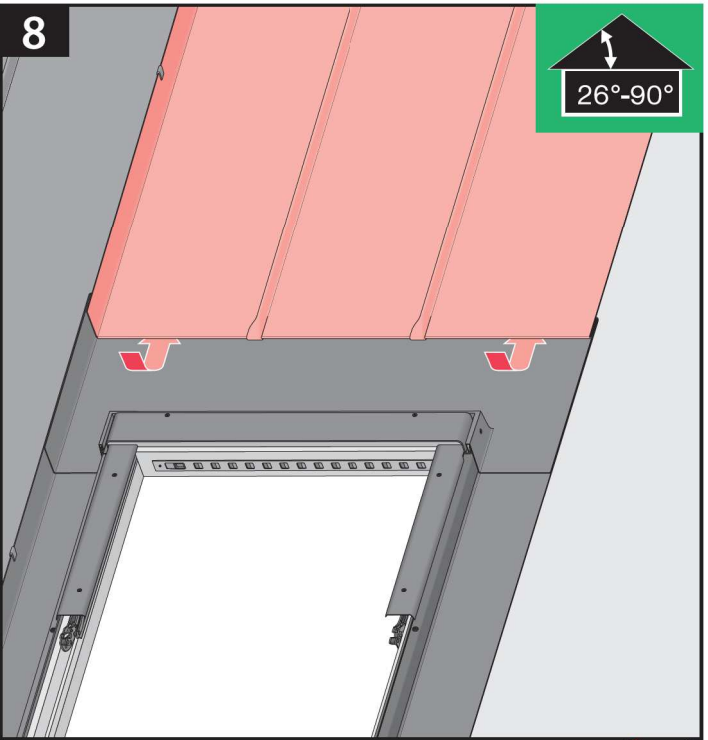

15°-25°

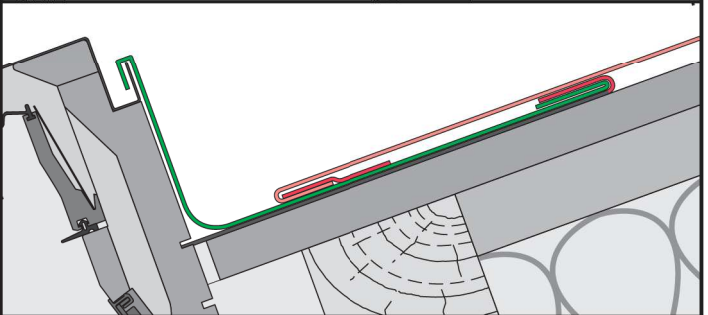
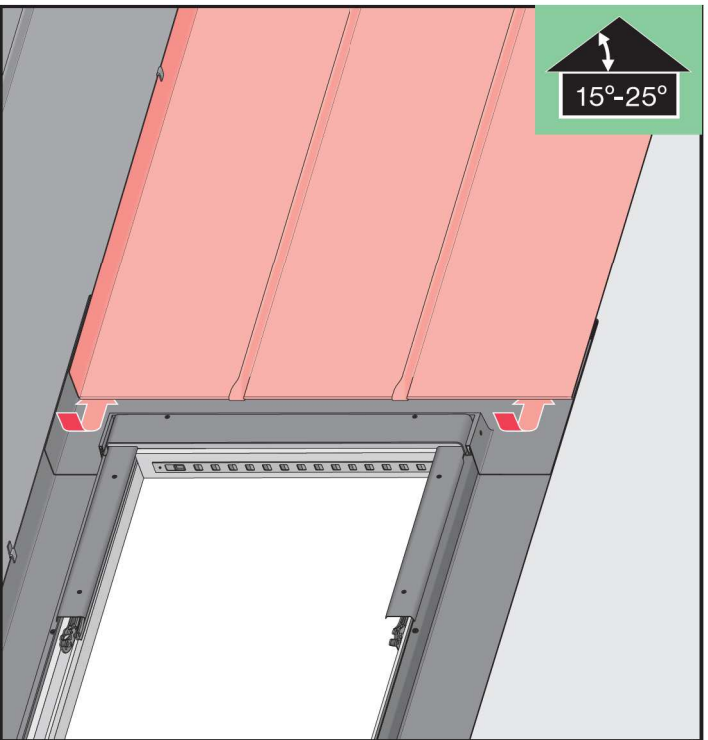

9

9

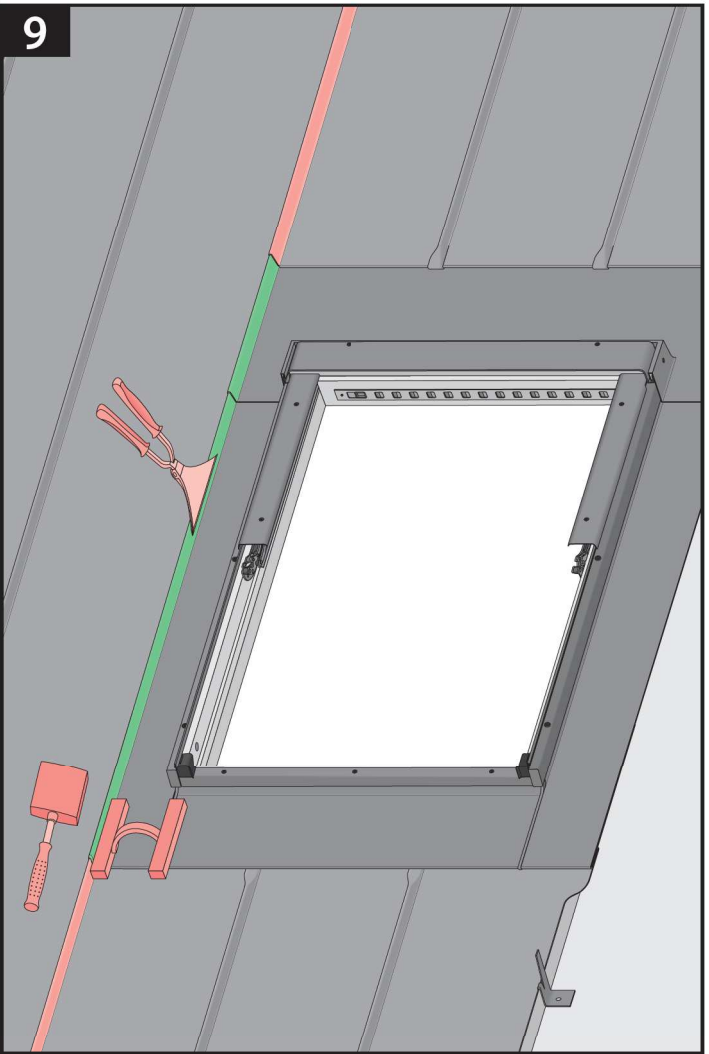

10

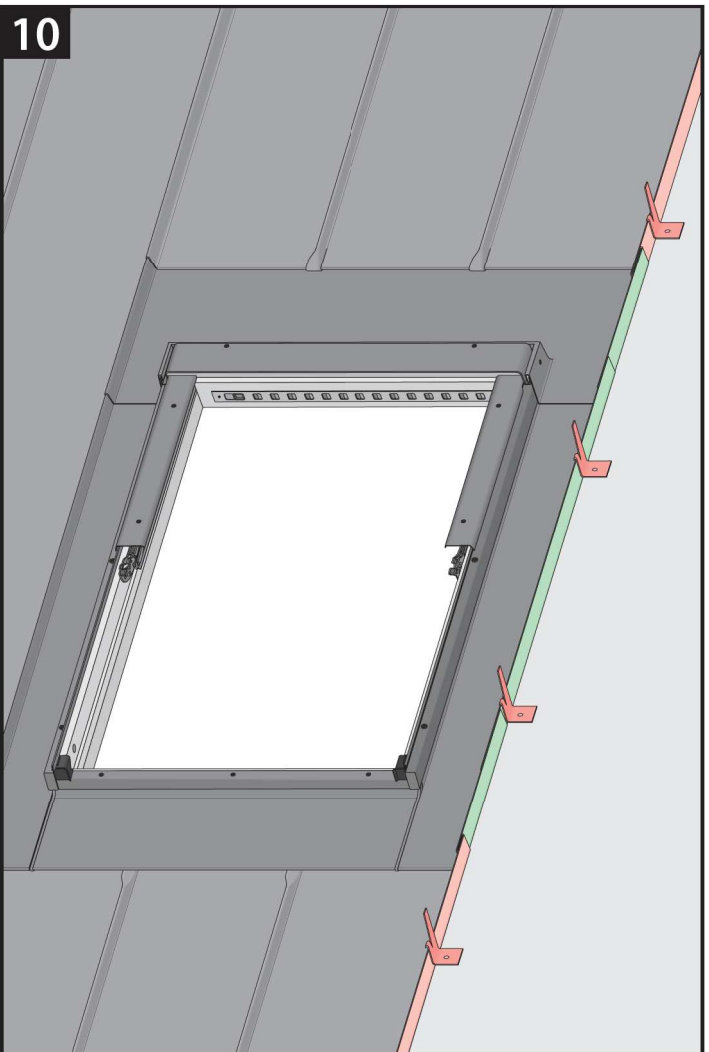

11

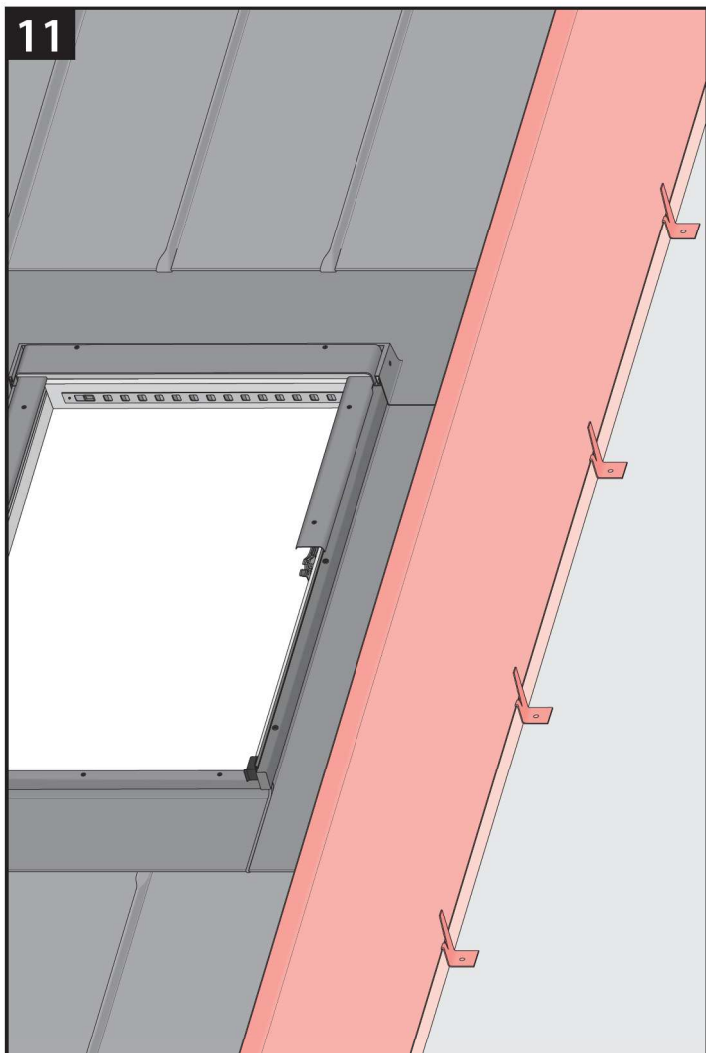

12

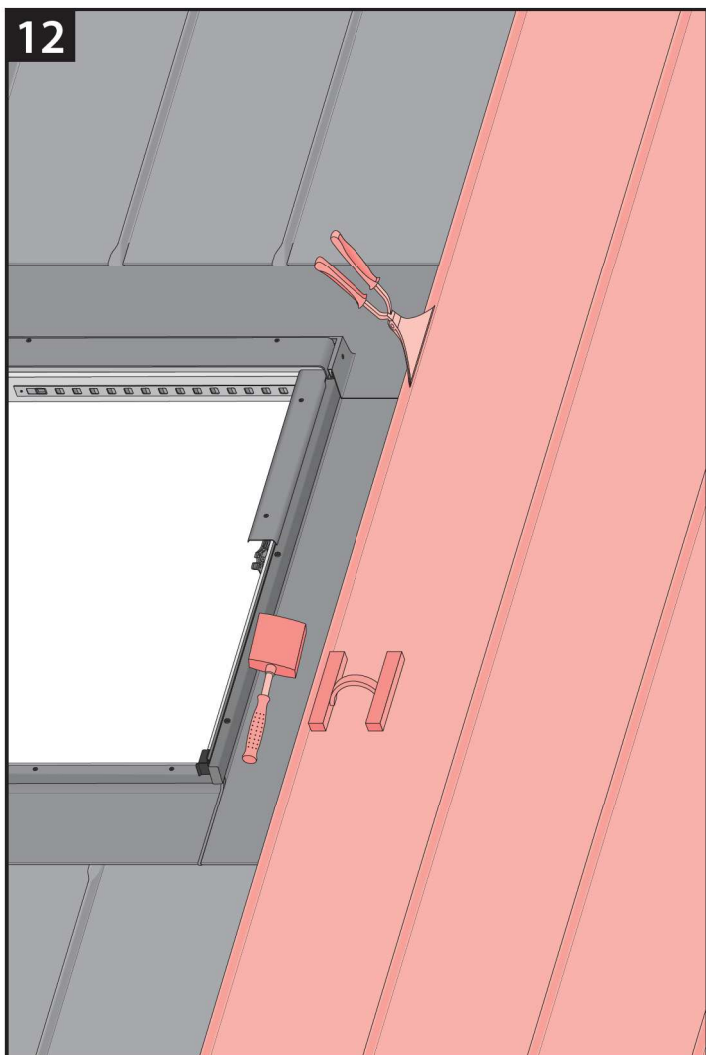

0 [cm] 1 2 3 4 5 6 7 8 9 10 11 12 13 14 15 16 17 18 19 20 21 22 23

CZ	Výrobce ani prodejce nenesou žádnou odpovědnost za nedodržení příslušných právních zákonů, stavebních předpisů a bezpečnostních požadavků uživatelem výrobku, architektem, montážníkem nebo vlastníkem budovy.	NL	De fabrikant en verkoper zijn niet aansprakelijk voor gevolgen bij het niet opvolgen van voorschriften, wetten, bouwvoorschriften en veiligheidsvoorschriften door de gebruiker van het product, de architect, de installateur of de eigenaar van het gebouw.
DE	Hersteller und Verkäufer übernehmen keine Haftung für Nichtbeachtung entsprechender Rechts- und Bauvorschriften sowie Sicherheitsanforderungen seitens Produktbenutzers, Architekten, Monteure oder Gebäudebesitzers.	PL	Producent i Sprzedawca nie ponosi żadnej odpowiedzialności za nieprzestrzeganie stosownych przepisów prawa, przepisów budowlanych i wymogów bezpieczeństwa przez użytkownika produktu, architekta, montażystę lub właściciela budynku.
ES	El fabricante y el vendedor no tienen ninguna responsabilidad por el incumplimiento de la ley vigente, normas de construcción y exigencias de seguridad por parte del usuario del producto, arquitecto, instalador o el propietario del edificio.	PT	O fabricante e o vendedor não tem nenhuma responsabilidade pelo o não cumprimento da lei, códigos de construção e as exigências de segurança por parte do usuário do produto, arquiteto, instalador ou proprietário do edifício.
FR	Le fabricant et le revendeur ne prend aucune responsabilité de ne pas respecter les lois applicables, les règlements sur les bâtiments et les exigences de sécurité par l'utilisateur du produit, l'architecte, l'installateur ou le propriétaire du bâtiment.	RO	Nici producătorul, nici distribuitorul nu își vor asuma niciun fel de răspundere pentru nerespectarea legilor în vigoare, a legilor din domeniul construcțiilor sau a măsurilor de siguranță impuse utilizatorilor produsului, arhitecților, montajorilor sau proprietarilor clădirii.
GB	Manufacturer and Seller shall bear no liability for failure to comply with the applicable laws, building codes and safety requirements by the user of the product, architect, fitter or owner of the building.	RU	В случае несоблюдения архитектором, монтажником или владельцем здания строительных правил и норм безопасности ответственность с производителя и продавца снимается.
HU	A Gyártó és a forgalmazó nem vállal semmiféle felelősséget a vonatkozó törvényi, építési és biztonsági előírások termékfelhasználónak, építész, beépítőmester vagy épülettulajdonos általi be nem tartásáért.	SK	Výrobca a predajca nenesú žiadnu zodpovednosť za nedodržanie príslušných ustanovení zákona, stavebných predpisov a bezpečnostných požiadaviek užívateľom výrobku, architektom, montérom alebo majiteľom objektu.
IT	Il Produttore e il Rivenditore non potranno essere ritenuti responsabili per il mancato rispetto, da parte dell'utente del prodotto, del progettista, dell'installatore o del proprietario dell'edificio, delle leggi vigenti, nonché dei regolamenti edilizi e di quelli relativi alla sicurezza.		